

WIF-1250 Water in Fuel Sensor

- ▶ Designed for OHV and Generator Set applications
- ▶ Compact size, easy to install
- ▶ Operates in plastic or metal tanks
- ▶ Reliable and affordable OEM solution
- ▶ Solid-State – no moving parts

The WIF-1250 sensor is an innovative, no-moving-parts solution specifically designed to detect the presence of water in fuel. The sensor is an ideal solution for OEM's of off-highway vehicles, locomotive and generator sets. It is also ideal for use with fuel filters. Based on reliable conductivity technology, WIF-1250 sensors are built from robust nickel plated steel for compatibility with temperatures up to 257°F (125°C), and are suited for the most challenging environments or applications. A 5-second delay circuit prevents "slosh" actuation. The sensor is easily mounted in any position.

Specifications

| | |
|-------------------------------|--|
| Housing Materials | Nickel plated steel, electrolytic nickel plated & fused glass conductivity pin insulator |
| Sensing Element Length | 0.2" (5.1 mm) |
| Operating Pressure | 750 PSI (51.7 bar) @ 70°F (21°C) |
| Operating Temperature | -40°F to 257°F (-40°C to 125°C) |
| Sensitivity | 10,000 Ohms (fluid resistance) |
| Slosh Dampening | 5 seconds |
| Supply Voltage | 8 to 32 V DC |
| Current Consumption | <20 mA |
| Output | Open collector, sinking output |
| Output Load Capability | 250 mA max. |
| Electrical Connection | 20 AWG 3-Conductor Cable, 15" (381 mm) |
| Approvals | CE |

Dimensions

1/4" NPT Mounting

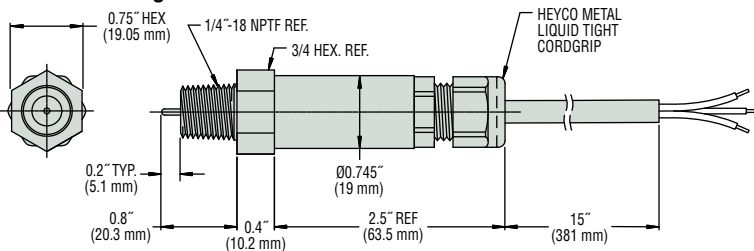

M12x1.5 Mounting

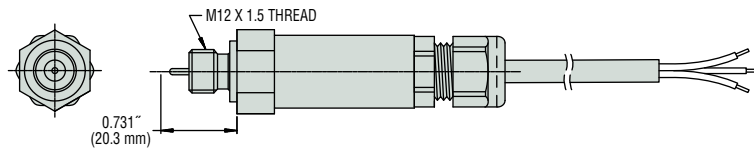

Typical Applications

To detect water in:

- Fuel filters
- Diesel fuel storage tanks

Wiring Diagrams

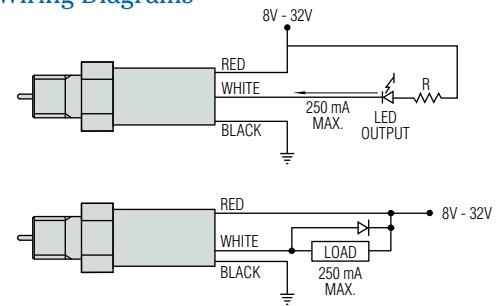

Resistance vs. Operating Temperature

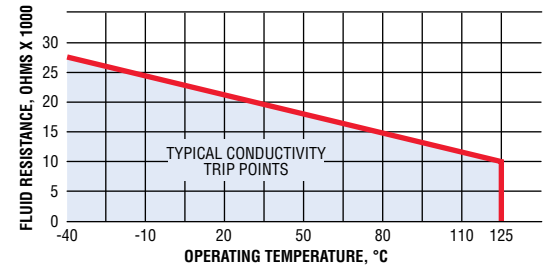

Operating Principle

WIF-1250 liquid level sensors are solid-state devices designed to detect the presence or absence of water in fuel. Each sensor contains integral, high-temperature-rated electronics that generate an alternating voltage to a probe tip. The presence of water completes the circuit which, in turn, changes the condition of the transistor output. Output options vary and can be used to actuate relays, indicator lights or LEDs, as well as to interface with CMOS/TTL logic, PLCs or microprocessors.

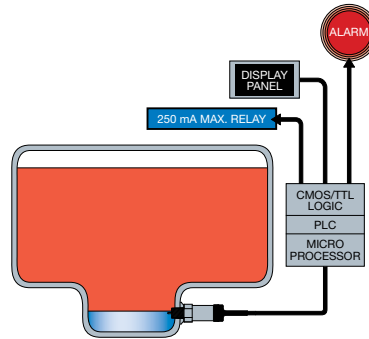

Conventional Conductivity Probe

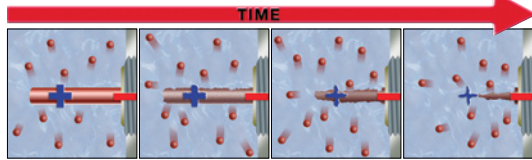

When a single potential (DC Voltage) is applied to a probe submerged in conductive liquid, metal from that probe will be lost over time via electrolysis.

Gems WIF-1250 Probe

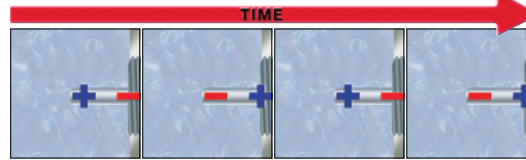

Gems applies extra circuitry to produce an alternating potential (alternating +/- DC square wave). Metal lost in one state is retrieved in the alternating state, resulting in virtually zero probe material loss.

How to Order

Select Part Number based on Mounting Thread and Switch Logic.

| Probe Condition at Current Sink | Part Numbers | |
|---------------------------------|--------------|---------|
| | 1/4" NPT | M12x1.5 |
| Wet | 238737 | 238856 |
| Dry | 238773 | 238855 |

LEVEL SWITCHES – SINGLE POINT