

65800 Series Single Channel Zener Barriers Render Switches or Signal Conditioners Intrinsically Safe

Limits D.C. voltage and current to the hazardous area and provides a path for fault current

- ▶ Intrinsic safety with solid-state reliability
- ▶ Compact size streamlines installation
- ▶ Space-saving in multiples
- ▶ Encapsulated construction is impervious to dust and moisture

The exceptionally compact design of GEMS 65800 Series units saves space and simplifies installation; especially in multiples on a common mounting plate. They provide great economy as well since no explosion-proof enclosures are needed for sensor wiring. Encapsulated construction is impervious to dust and moisture. Single-screw mounting is standard, but units can be supplied with an optional clip for rail mounting. The single through-mounting screw also provides electrical connection to ground through the earth-grounded mounting surface.

Any non-voltage-producing sensor or switch is rendered intrinsically safe for hazardous locations when properly connected to the output of these Zener Barriers.

See table on Page L-2 for specific approval information.

Typical Wiring Diagram

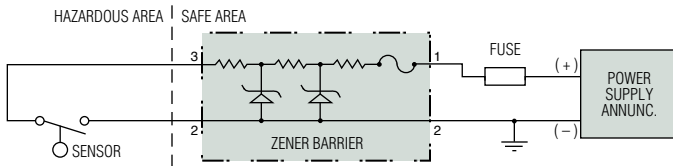

Positive single-channel Zener Barrier with negative ground.

For most non-voltage-producing devices located in a hazardous area, a single Zener Barrier that is negative-earth-ground can be used for intrinsic safety. Instrumentation that produces an output (signal conditioners) usually requires two barriers, one for each "floating" lead. In this case, a dual channel barrier can be provided (see L-10 and L-11).

Or, for applications where the instrument signal return level cannot be reduced, a supply barrier and a low resistance return barrier can be supplied (shown below).

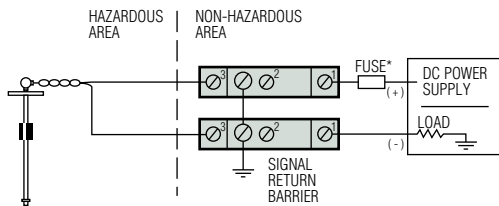

For floating leads: 65800 Series supply and return barriers for signal conditioners.

Installation and maintenance must be in accordance with the National Electrical Code and the applicable Gems INSTRUCTION, INSTALLATION and SERVICE bulletin available at www.gemssensors.com

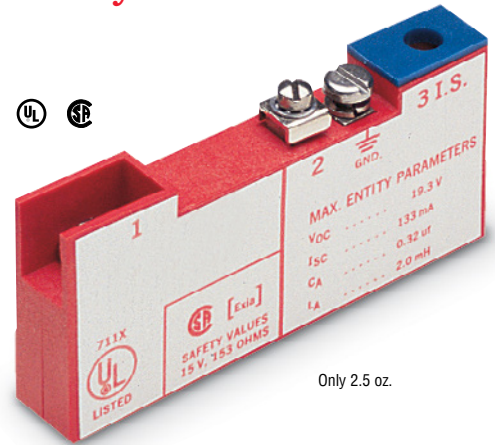

Dimensions

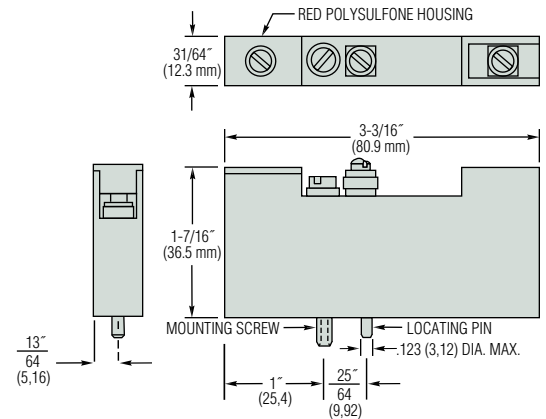

Protective Cover

Protective cover over the output terminal (3) assures intrinsic safety of sensor wiring.

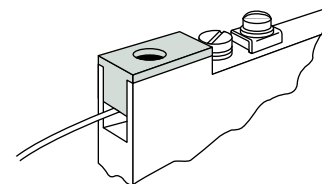

Optional Rail Mounting

Gems Single Channel Zener Barriers can be supplied on special order with a clip for rail mounting. Clip attaches to barrier with standard mounting screw.

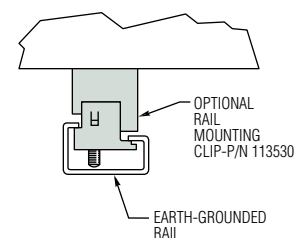

How To Order

Specify Part Number based on Barrier Type and Input Power requirements.

Zener Barrier Type	DC Input to Barrier, Max.		Signal Polarity	Series Resistance ohms	Application Group	Reactive Limits		Part Number
	Voltage	Current				Capacitance μ f	Inductance mh	
Supply	+15	250 mA	Positive	183	A, B, C, D, E, G	0.32	2.0	111950 ⚡
	+20	125 mA		303		0.18	4.1	111952
	+24	62 mA		390		0.12	3.0	111954
	+30	62 mA		750		0.07	1.8	111956
	+18	125 mA		183	C, D, E, G	0.72	3.6	114074
	+24	62 mA		234		0.33	3.1	114072
	+27	62 mA		276		0.24	3.3	114175
	+30	250 mA		303		0.20	3.0	113000 ⚡
Signal Return	+30	250 mA		33.9	A, B, C, D, E, G	0.07	.35	114166 ⚡
Optional Rail Clip								113530 ⚡

Notes:

- All models shown are for Class I and II, Division 1 and 2. Specific Application Groups are tabulated.
- Ambient operating temperatures for all models shown is -40°F to +140°F (-40°C to +60°C).

⚡ – Stock Items.

Typical Application Examples

Sensors or Switches may be any non-voltage-producing device. Typical are: flow and level switches, temperature switches (thermostats), pressure switches or passive resistive transducers or transmitters. Below are typical examples.

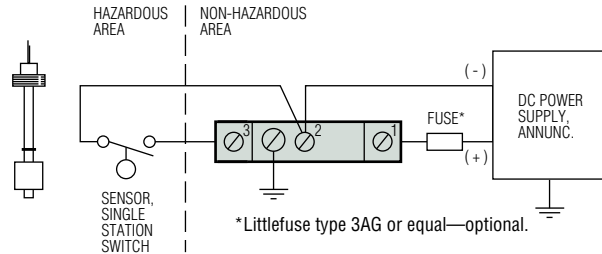

With GEMS level switch or any other non-voltage-producing device located in a hazardous area.

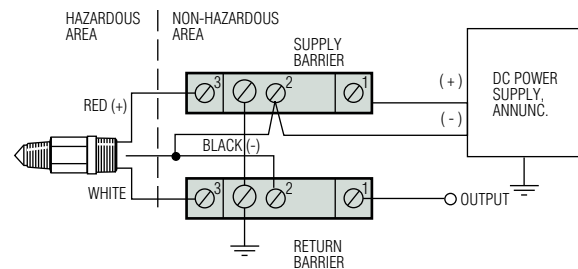

Supply and Return Zener Barriers used with GEMS EL-1100 Series electro-optical level switch.

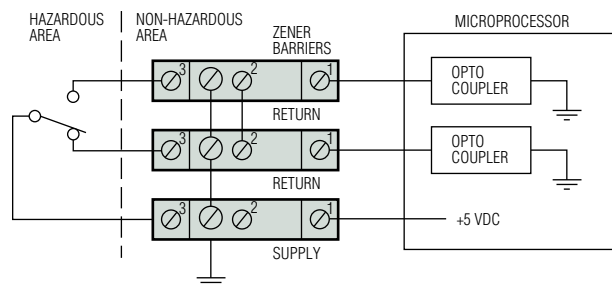

For optically coupled microprocessor. 65800 Series supply with two return barriers for SPDT switch.

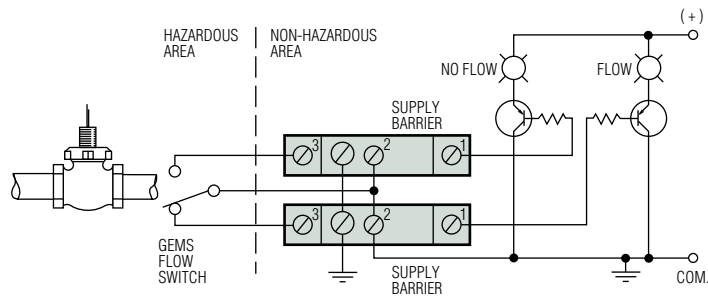

Used with GEMS flow switch located in a hazardous area for flow/no flow indication.